

SEDILIA

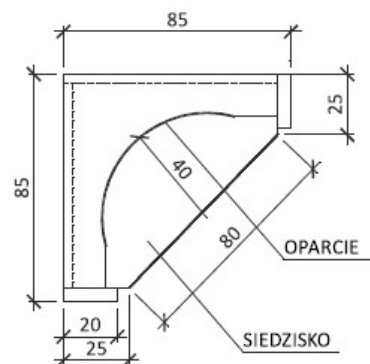

SEDILIA



PODSTAWA POD
TABERNAKULUM

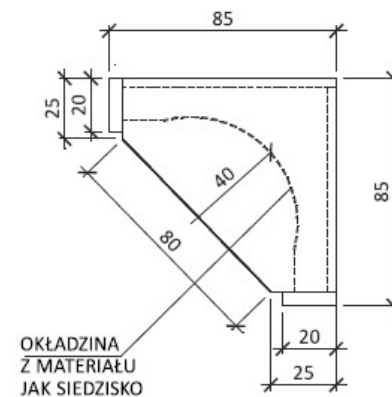

PODSTAWA
POD TABERNAKULUM

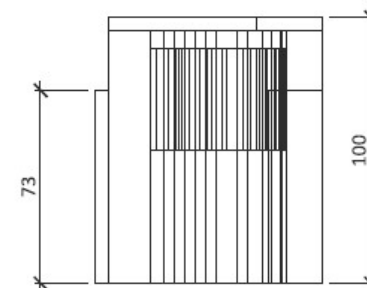
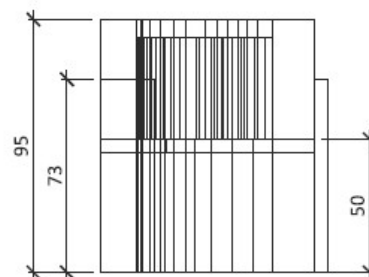

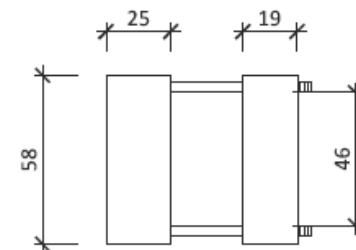
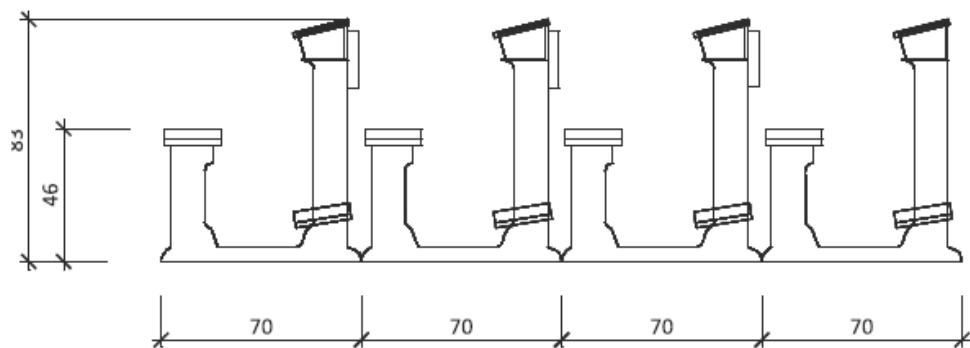

Rysunek 2: do załącznika nr 1 - Lp. 3

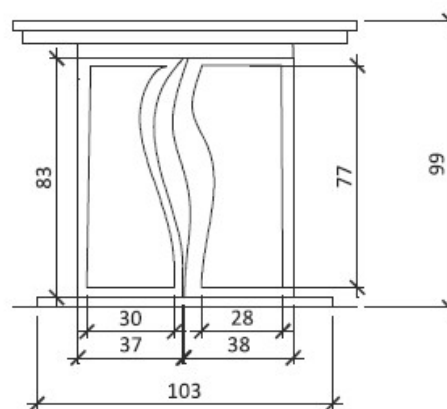
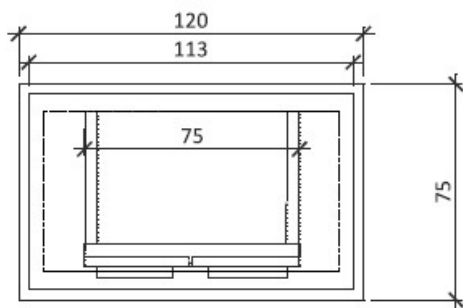

Rysunek 3: do załącznika nr 1 - Lp. 4

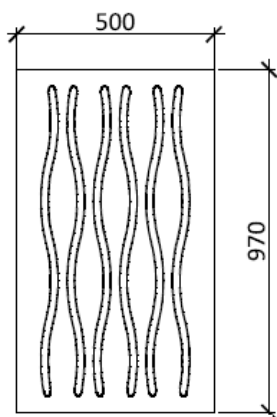
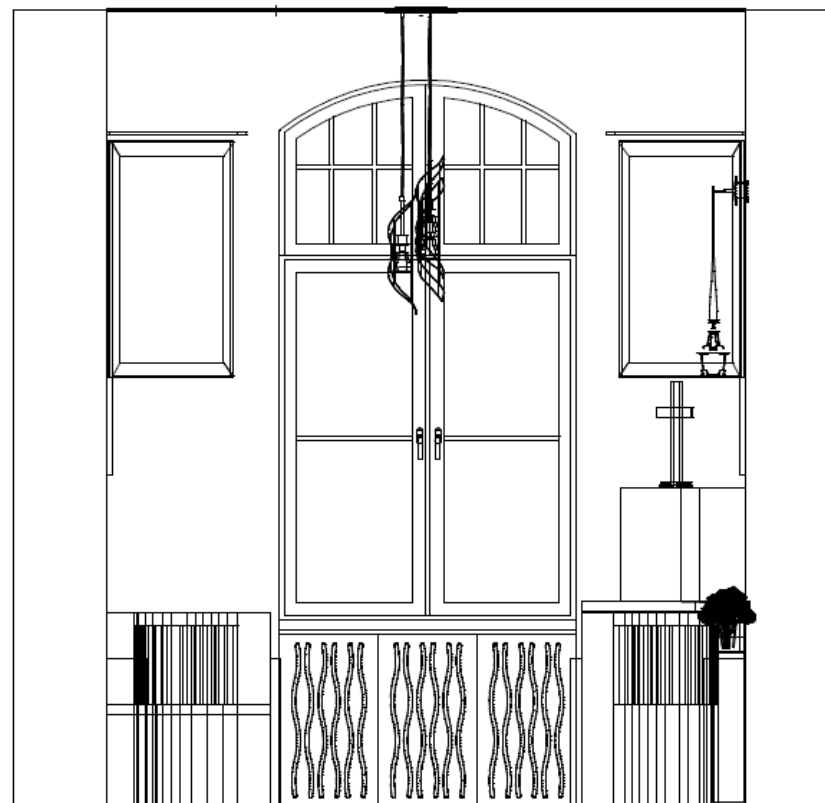

ELEMENT OBUDOWY GRZEJNIKA WYMIARY PRZYBLIŻONE - DO POTWIERDZENIA Z NATURY

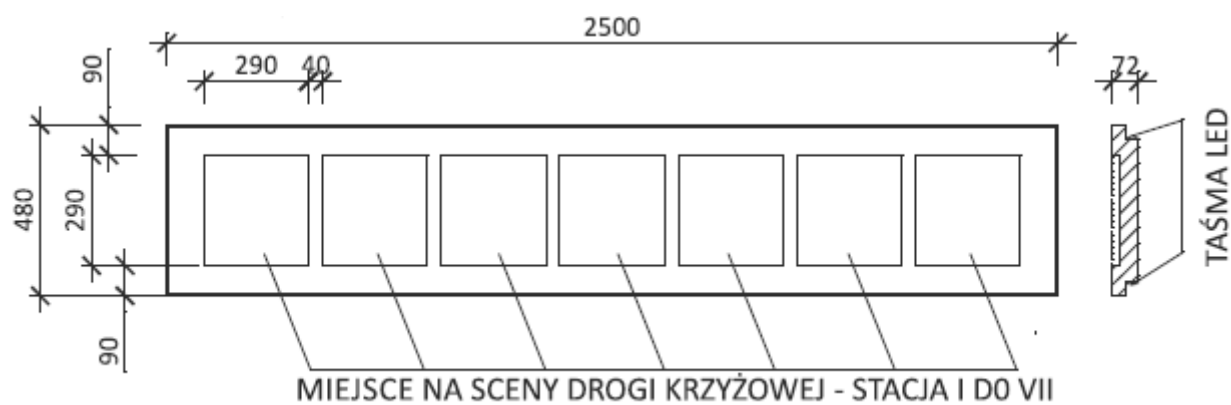

Rysunek 5: do załącznika nr 1 - Lp. 6

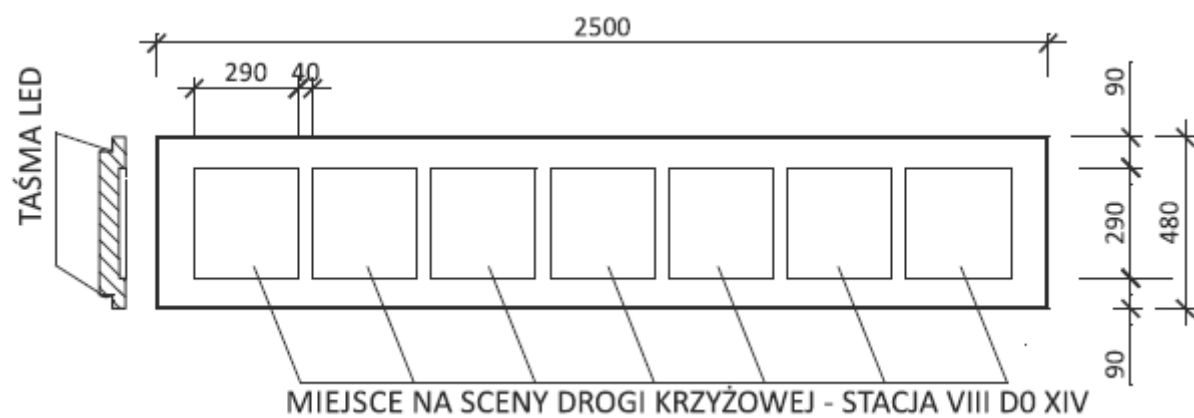

Rysunek 6: do załącznika nr 1 - Lp. 7

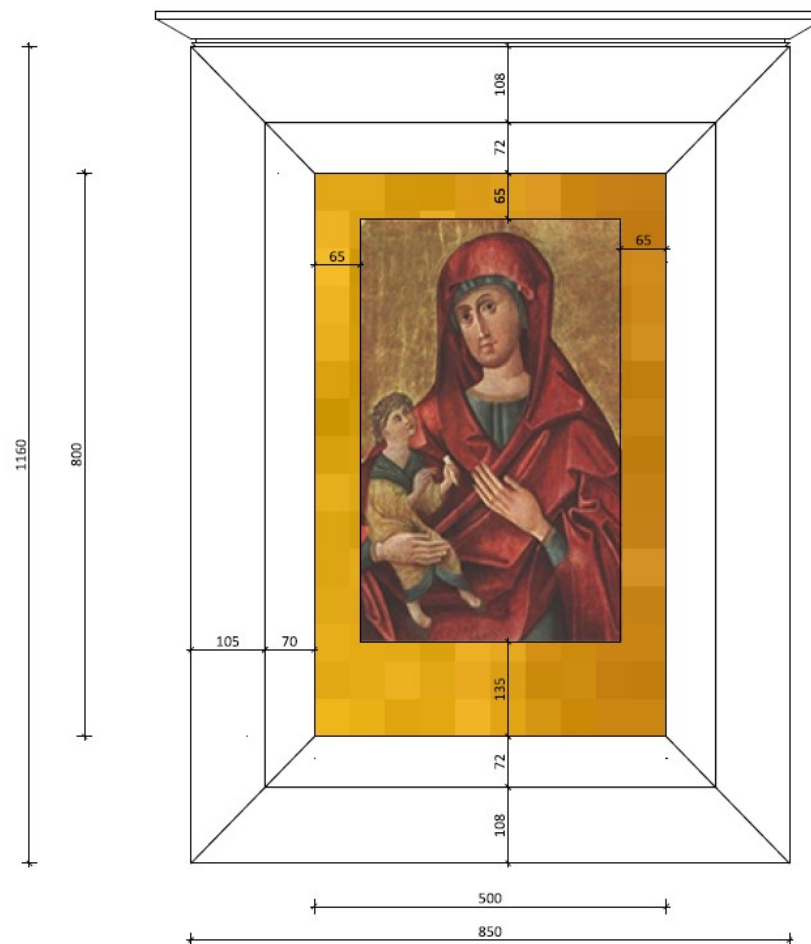

Rysunek 7: do załącznika nr 1 - Lp. 8

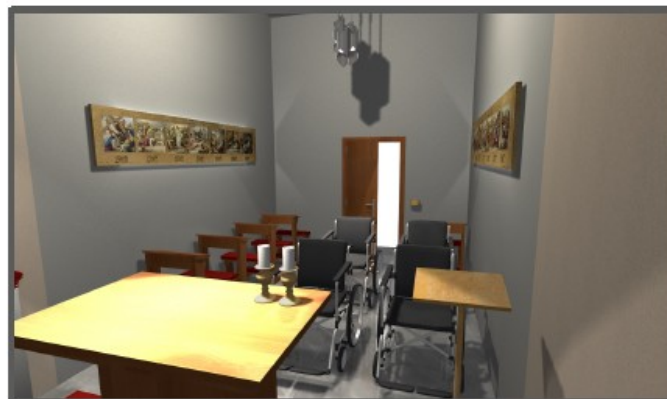
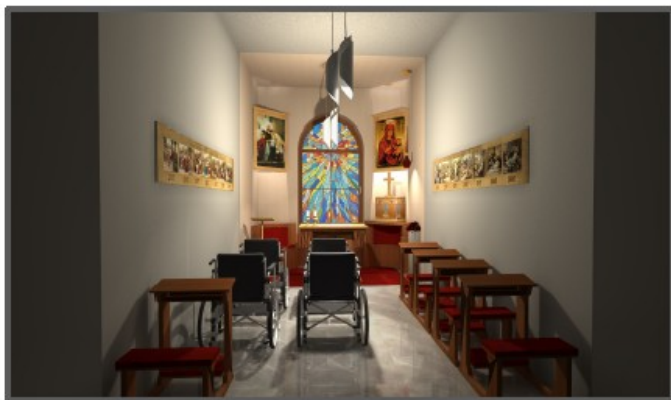

DL.26.15.2024

Załącznik nr 5

